

CT 11A & CT 11B

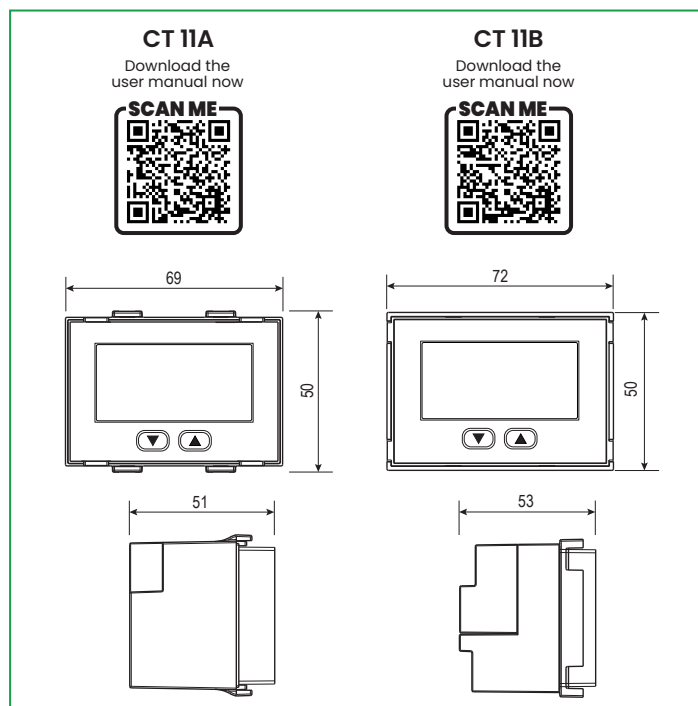

Post office box 5 31049
Valdobbiadene (TV)
www.4green.it

Device dimensions



Connection diagrams

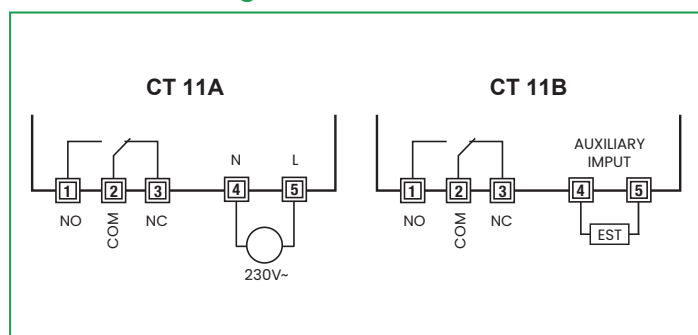

Device description

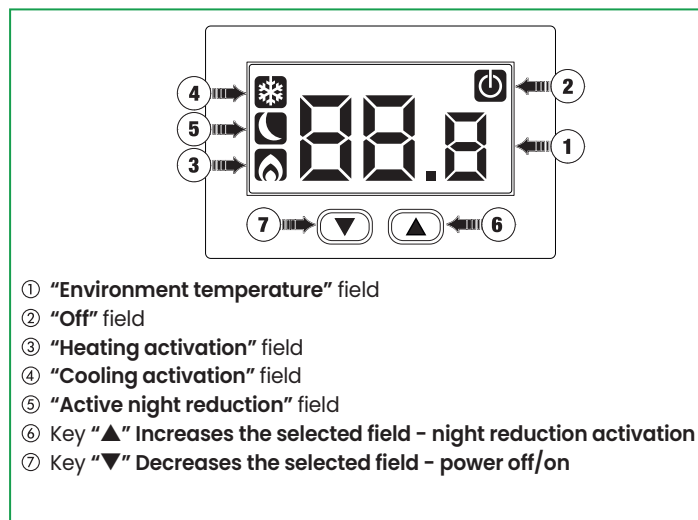

Reference standards

08-2025

- Compliance with Community Directives 2014/35/UE (LVD) and 2014/30/UE (EMCD) is declared with reference to the following harmonized standards • EN 60730-2-9 • EN 62479

V3IS01210-010

User Manual

⚠ Read all the instructions carefully

ELECTRONIC THERMOSTATS

Flush-mounting electronic thermostats for temperature control both in heating and cooling. They perform actions of type 1B and are intended for operating in environments with Pollution Degree 2 and Overvoltage Category III (EN60730-1).

- CT 11A, with mains power supply.
- CT 11B, with battery power supply and configurable auxiliary input for the connection of a temperature probe or an external contact with whom to reduce the setpoint of 3°C.

Code	Model	Description
4G000600	CT 11A	230V Thermostat
4G000700	CT 11B	Battery thermostat with auxiliary input

SAFETY WARNINGS

During product installation and operation it is necessary to observe the following instructions:

- 1) The device must be installed by a qualified person, in strict compliance with the connection diagrams.
- 2) Do not power or connect the device if any part of it is damaged.
- 3) After installation, inaccessibility to the connection terminals without appropriate tools must be guaranteed.
- 4) The device must be installed and activated in compliance with current electric systems standards.
- 5) Before accessing the connection terminals, verify that the leads are not live.
- 6) In the electrical system of the building where the device must be installed, a protection device from the overcurrents must be present (for CT 11A only).

TECHNICAL SPECIFICATIONS

- Power supply CT 11A: - 230 Vac (-15% ÷ +10%) 50/60 Hz - max absorption: 6 VA / 230 Vac
- Power supply CT 11B: - 2 alkaline batteries 1.5 V (AAA type) - battery life: 12 months - depleted batteries indication
- Installation on 3 modules box (503 type)
- Morsettiera CT 11A: - 3 terminals for 1.5 mm² cables for bistable output relay 5 A / 250 Vac - 2 terminals for 1.5 mm² cables for power supply
- Terminals CT 11B: - 3 terminals for 1.5 mm² cables for output relay 5 A / 250 Vac - 2 terminals for 1.5 mm² cables for digital input (to connect a temperature probe or an external contact to reduce the setpoint by 3°C)
- Operating mode: summer/winter/off (with antifreeze)
- Password protected lock keypad
- Regulation type: - on/off with settable differential (0.1°C ÷ 1°C) - P8 proportional with 0.8°C band (-0.3°C ÷ 0.5°C) and period 8 minutes - P15 proportional with 1.5°C band (-0.7°C ÷ 0.8°C) and period 15 minutes
- Measurement precision: ± 0.5 °C
- Measurement temperature resolution: 0,1 °C
- Setpoint range: 2 °C ÷ 50 °C
- Operating temperature: 0 °C ÷ 50 °C
- Storage temperature: -10 °C ÷ 65 °C
- Operating humidity: 20 ÷ 90% non condensing
- Protection degree: IP40
- Insulation: reinforced among accessible parts (frontal) and all other terminals



Information to users pursuant to art. 14 of the directive 2012/19 / EU of the european parliament and of the council of 4 July 2012 on waste electrical and electronic equipment (WEEE)

If the crossed-out bin symbol appears on the equipment or packaging, this means the product must not be included with other general waste at the end of its working life.

The user must take the worn product to a sorted waste center, or return it to the retailer when purchasing a new one.

Products for disposal can be consigned free of charge (without any new purchase obligation) to retailers with a sales area of at least 400 m², if they measure less than 25 cm.

An efficient sorted waste collection for the environmentally friendly disposal of the used device or its subsequent recycling, helps avoid the potential negative effects on the environment and people's health, and encourages the re-use and/or recycling of the construction materials.

Installation

- Install the thermostat in a 3-module flush-mounting box (type 503) at a height of about 1.5 m above the floor in an area which respects as much as possible the average temperature conditions of the whole room. Avoid installation near doors or windows, in niches, behind doors and curtains or in positions with excess or total lack of ventilation, in order to prevent the temperature reading measured by the probe from being somewhat offset.
- Make the connections by respecting the diagrams described in this manual.
- Fix the device inside the 3 modules box in compliance with the assembly diagrams described on the back of this instruction sheet. The installation accessories allow for adaptability with the main domestic range.

Reset

Reset to delete the settings you made and reload the default values. To reset:

- 1) remove and restore power to the device (CT 11A) or remove it from the base and re-insert it (CT 11B).
- 2) during the flashing of the backlighting press the keys ▲ and ▼ until dEF will appear.

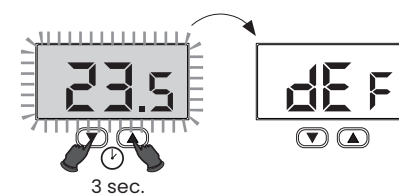

Default values

Heating setpoint	21 °C
Cooling setpoint	25 °C
Minimum settable setpoint - <i>LO</i>	2 °C
Maximum settable setpoint - <i>HI</i>	50 °C
Operating mode	(heating)
Antifreeze temperature	6 °C
Regulation type	On /Off
Differential	0,3 °C
Auxiliary input	DIG
Password	--- (disabled)

Battery replacement (only for CT 11B)

In the event of low batteries, the device display will alternately show:



Replace the batteries as soon as possible.

The extraction of the device, to access the battery compartment, takes place by pulling on the convexity of the front panel.

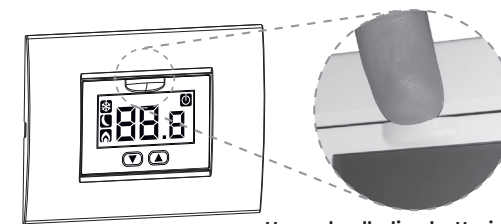

Use only alkaline batteries

⚠ It is necessary to remove the batteries before the instrument is scrapped.

⚠ In case of replacement, dispose of the batteries in the special containers of separate waste collection.



Mounting CT 11A

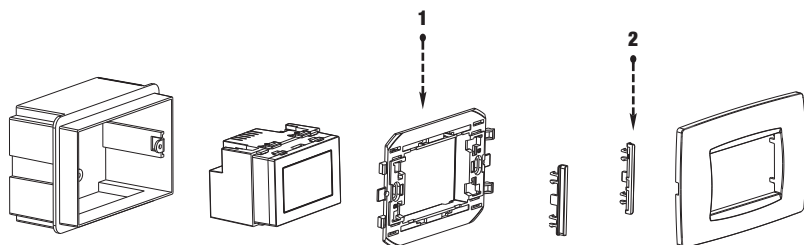

Note:

1. Choose the adaptability frame based on the compatibility table (see BOX "Adaptability frames") for the domestic range.
2. Insert, if necessary, plastic elements (see BOX "Adaptability frames")

Mounting CT 11B

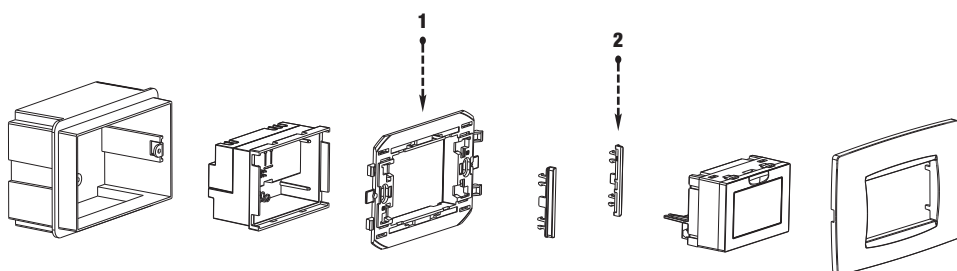

Note:

1. Choose the adaptability frame based on the compatibility table (see BOX "Adaptability frames") for the domestic range.
2. Insert, if necessary, plastic elements (see BOX "Adaptability frames")

Adaptability frames

FRAMES	SERIES
A	ABB: Mylos
	AVE: S44
	BTICINO: Living, Light, Light Tech, Livinglight, Axolute VIMAR: Eikon, Eikon Evo, Plana
B	ABB: Chiara
	BTICINO: Matix *
	GEWISS: Chorus *
	VIMAR: Arkè, Idea

Note:

* remove the teeth from the frame for proper compatibility (see figure below).

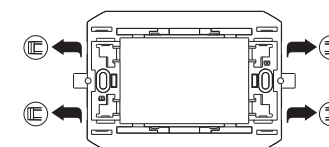

PLASTIC ELEMENTS

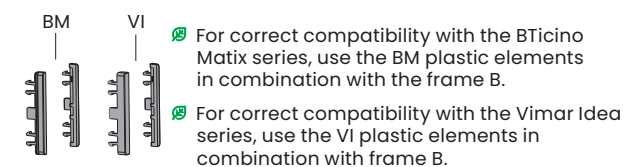

Operation

During the standard operation the thermostat displays the detected temperature value and the relay status is identified by the symbol (heating mode) or the symbol (cooling mode).

Setpoint modification

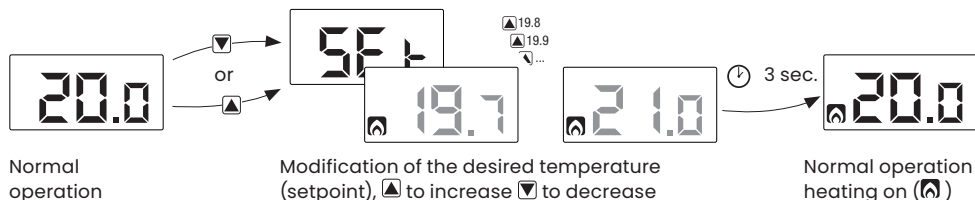

Night reduction

(only for CT 11B)

The "night reduction" function reduces the setpoint of 3 °C. Press the key for 3 seconds to activate (or deactivate, if already active) the night reduction.

When the reduction night is active, a display lights up the symbol .



Backlighting management

CT 11A

The CT 11A has a backlighting of blue colour which is on during normal operation.

If the installation makes it necessary (for example bedrooms) you can turn off the backlighting. In this condition the thermostat continues to operate normally and the backlighting turns on when you enter setpoint modification menus, advanced programming, pin enter.

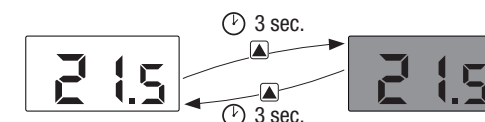

CT 11B

The CT 11B has a backlighting of blue colour that is normally off and turns on when a key is pressed.

Switch off

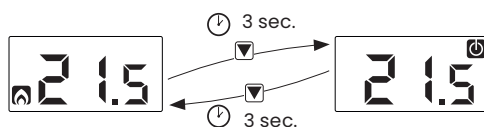

Note: in heating mode (winter), the device if off, it regulates according to the antifreeze temperature **Toff** in order to prevent freezing of the system.

Toff can have values from 1°C to 50°C or be excluded; in this case any minimum temperature is guaranteed.

Error messages

Occurs for the following values of measured temperature:
 $t < 0\text{ °C}$
 $t > 50\text{ °C}$ ($t > 60\text{ °C}$ with external probe)

Occurs in case of probe failure. In this case the regulation is inhibited and the relay contacts remain in position 2-3.

Advanced programming

To enter menu Advanced programming keep simultaneously pressed for 3 seconds the keys and until **Pr** will appear. The items of the menu are displayed in succession. For each item is displayed an identification abbreviation and its relative blinking value. Use the keys and to modify the value.

The passage to the next parameter occurs after 3 seconds without pressing any key. Once all parameters are set the writing **End** is displayed and the thermostat returns to normal operation saving the effected modifications.

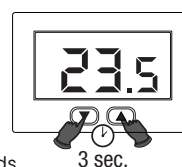

Minimum settable setpoint - L0
 It's the minimum value settable as setpoint.
 Settable values: 2 ÷ 50 °C

Maximum settable setpoint - H1
 It's the maximum value settable as setpoint.
 Settable values: L0 ÷ 50 °C

Operating mode - E-1
 if connected to the boiler (heating)
 if connected to a cooling system

Antifreeze temperature - Toff - (only in heating)
 Minimum temperature maintained with device off (see box «Switch off».)
 Settable values: 1 ÷ 50 °C or --- (excluded function)

Regulation type - rEG - (only in heating)
 = on/off with settable differential
P8 = proportional with band 0.8°C and period 8 minutes
P15 = proportional with band 1.5°C and period 15 minutes

Differential - d0.3 - (only for on/off regulation)
 Differential (or hysteresis) for temperature regulation.
 Settable values: 0,1 ÷ 1 °C

Input configuration - Est - (only for CT 11B)
 - or the connection of a temperature probe
 - **d10** for the connection of an external contact to reduce the setpoint. With the external contact closed, the setpoint is reduced by 3 °C with respect to the value set and the symbol appears on the display.

Lock password - PR5 (00 1-999)
RL to prevent any changes (keypad lock)
PRr to prevent access to advanced programming
 Set "----" to disable the lock.
 If the password is requested and it is entered correctly, the instrument is unlocked for the following 30 seconds.